

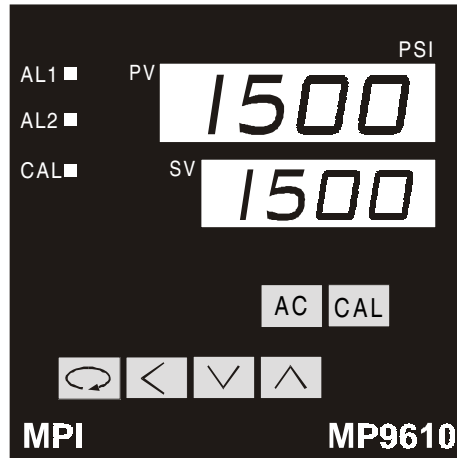

MELT PRESSURE ALARM

MODEL MP9610



STANDARD

- PRESSURE TRANSDUCER INPUT**
- SCALEABLE RANGE**
- ALARM HIGH**
- ALARM LOW**
- AUTO CALIBRATION**
- AUTO ZERO**
- LOCKOUT**
- PROCESS VALUE - RETRANS**

MODEL CODE

MP9610-PRR- RETRANSMISSION of PROCESS VALUE

M	4-20mA
0	0-10mA
1	0-20mA
5	0-5VDC
6	1-5VDC

TERMINAL CONFIGURATION

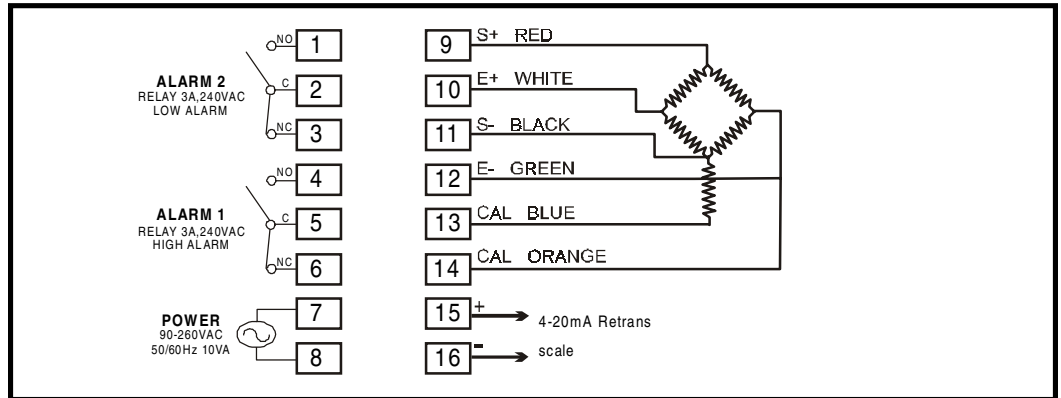

SPECIFICATIONS

1. INPUT - PRESSURE TRANSDUCER

350ohm STRAIN GAUGE	3.3mV/V
EXCITATION VOLTAGE	10VDC
ACCURACY	+/-0.5%
SAMPLE RATE	250mS

2. ALARM OUTPUTS

ALARM 1	5A/240VAC resistive
ALARM 2	5A/240VAC resistive

3. RETRANSMISSION of PROCESS VALUE

CURRENT	4-20mA, 0-20mA, 0-10mA Max load 500 ohm
VOLTAGE	0-5VDC, 1-5VDC Max 20mA

4. POWER

RATING 85 - 265 VAC 50/60Hz 10VA max

5. ENVIRONMENTAL

OPERATING TEMP	-10 - 50C
HUMIDITY	90% MAX
INSULATION	20M ohms minimum @ 500VDC
WEIGHT	300g

6. PHYSICAL DIMENSIONS

MP9610	96mmW x 48mmH x 100mmD
MP9610 Cutout	91mmW x 45mmH +/-0.5mm

TOLL FREE (800) 817-3486

PH (416) 675-7329

FX (416) 675-7349

ZERO DISPLAY

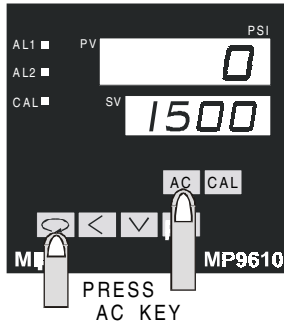
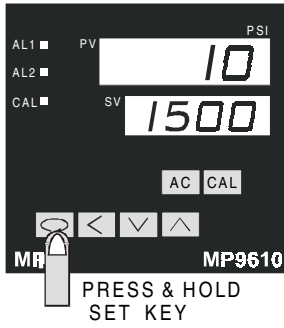

AUTO CAL

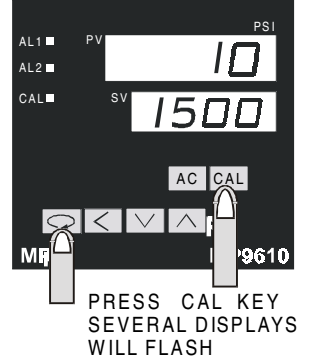
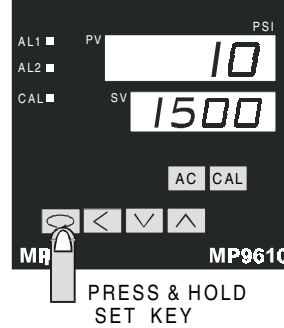

CHANGE ALARM 1 (AL1)

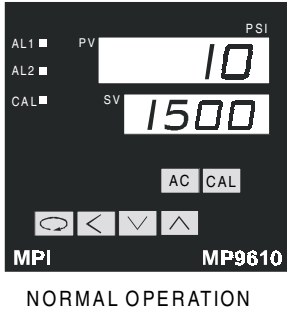

NORMAL OPERATION



PRESS SET KEY
RIGHT DIGIT FLASHES

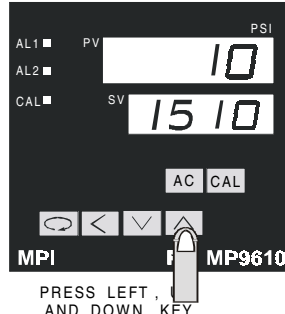

PRESS LEFT
AND DOWN KEY
TO CHANGE ALARM POINT



PRESS SET KEY
TO ENTER NEW VALUE

CHANGE ALARM 2 (AL2)

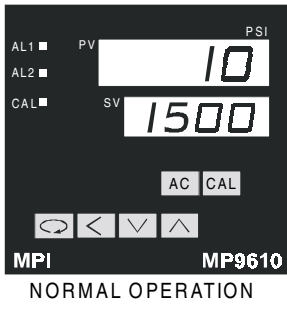

NORMAL OPERATION



PRESS SET KEY
RIGHT DIGIT FLASHES



PRESS SET KEY
5 SECONDS
ENTER MENU LEVEL



PRESS SET KEY
7 TIMES

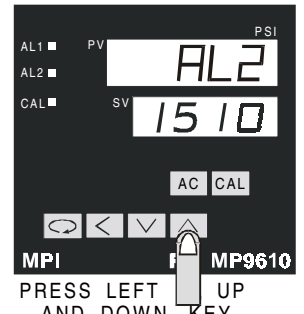

PRESS LEFT
UP
AND DOWN KEY
TO CHANGE ALARM POINT

CODE	PARAMETER	RANGE	DEFAULT
rn	MEASUREMENT RANGE	500 - 9999	9999
du	DISPLAY GRADUATION	1, 2, 5	5
dot	DO NOT ADJUST	DO NOT ADJUST	DO NOT ADJUST
AL1	ALARM 1	0 - 9999	8000
SEL1	ALARM 1 TYPE	0 - NONE 1 - LOW ALARM 2 - HIGH ALARM	2 - HIGH ALARM
dLY1	ALARM 1 HYSTERESIS	0 - 100	10
AL2	ALARM 2	0 - 9999	1000
SEL2	ALARM 2 TYPE	0 - NONE 1 - LOW ALARM 2 - HIGH ALARM	1 - LOW ALARM
dLY2	ALARM 2 HYSTERESIS	0 - 100	10
ESC	DO NOT ADJUST	DO NOT ADJUST	DO NOT ADJUST
OUT	RETRANS PROCESS VALUE	0u10 0-10VDC 4-20 4-20mA 0-20 0-20mA	0-10 0-10mA 0-5 0-5VDC
LCK	LOCK	0000 - NO LOCK 0001 - ALL LOCKED	0000 - NO LOCK

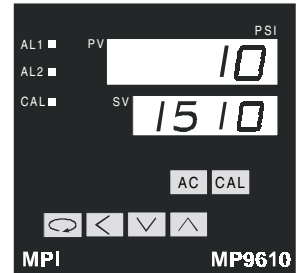

PRESS SET KEY 5sec
EXIT MENU LEVEL

**TORONTO, ONTARIO
CANADA**

PH (416) 675-7329
FX (416) 675-7349

DISTRIBUTOR